



無敵 CD-637P 電腦辭典

User's Manual

使用說明書



Index

Attention.....	1
Introduction of the device	
1. Layout.....	2
1.1 Obverse Side.....	2
1.2 Reverse Side.....	2
1.3 Key Description.....	2
1.4 Touch Panel.....	3
2. Keyboard.....	3
3. The Panel.....	12
4. Power Source.....	12
4.1 Replacing Battery	12
4.2 Recharging Battery	13
5. Initialization or RESET.....	13
6. Introduction of the functions.....	15
6.1 Input Methods.....	16
6.2 Handwriting Recognition.....	16
6.3 USB Disk.....	18
6.4 Download Operation.....	19
6.4.1 Automatic searching function.....	19
6.4.2 Create new folder for downloading data.....	21
DICT	
Dictionary Summary.....	24
1. Dictionary Index.....	28
1.1 History.....	28
1.2 Classification.....	29
1.3 Language Selection.....	29
2. Dictionary Explanation.....	29



Index

2.1 Font Size.....	30
2.2 Saving Data.....	30
2.3 Pronunciation.....	30
2.4 Repetition.....	31
2.5 Read after the Device.....	31
2.6 Pronounce Chinese words word by word.....	31
3. Strokes.....	32
4. Searching Data.....	32
4.1 Smart Input Search.....	32
4.2 Wildcard Search.....	33
4.3 Cross Search.....	33
4.4 Secondary Search.....	34
4.5 Multi-layered Search	34
5. Search Engine.....	35
6. Sentence Translation.....	37
7. Chinese Learning.....	40
STUDY	
Study Summary.....	42
1. Language Study Series.....	44
2. English Study Series.....	45
MULTI	
Multi Summary.....	48
1. Video.....	50
2. Animated Study Series.....	51
3. eBook/Text Browser.....	52
4. My Album.....	52



Index

5.MP3.....	53
6. Games World.....	55
PIM	
PIM Summary.....	56
1. PIM.....	58
1.1 Data Input.....	58
1.1.1 Custom Field.....	58
1.1.2 Edit Category.....	59
1.2 Data Index.....	59
1.3 Detail View.....	60
2. World Time.....	60
3. Paint Brush.....	60
4. Calculator and Conversion.....	61
SYS	
System Summary.....	62
1. PC Link.....	63
2. File Management.....	63
2.1 Creating New Folder.....	64
2.2 Rename.....	65
2.3 Putting Folders in Order.....	65
2.4 Format.....	65
3. My Favorite.....	66
PC Service Home.....	67
Maintenance.....	84



Attention

Data Backup

All your personal data should be copied to separate permanent printed records. Resetting the product will cause personal data loss permanently. Such loss is not covered by warranty.

Touch Panel & Display

- * To protect the screen from being scratched, use only the stylus that comes with this product.
- * When cleaning, rub the screen lightly with dry, clean and soft cloth (do not use volatile liquid).
- * The screen may crack if the product falls on the ground.

Extended Card

- * Insert the Secure Digital Card/Multi Media Card into the card slot. Turn the product off before removing/inserting the card. Otherwise, the memory of the product may be lost and the card may be damaged.
- * Do not remove the battery, turn the power off or insert/remove the card during data saving to avoid abnormality of the product.

Battery & Earphone

- * Keep the battery far from the fire. Otherwise, there is a risk of explosion. Do not connect the battery's terminals together to avoid short circuit.
- * The sound volume of the earphone should be not too high so as not to injure your hearing.

Non Waterproof

The device is non waterproof. Please keep it away from any liquid. If it gets wet, please dry the surface and send to our service center for checking.

Magnetism

The product is magnetic. Please do not place it with other magnetic products to avoid losing some functions.

Notes:

Any damage caused by above reasons is not covered by the warranty.



Introduction of the device

1. Layout

1.1 Obverse Side:

- ① Screen
- ② Tablet key (Right)
- ③ Speaker
- ④ Microphone
- ⑤ Keyboard
- ⑥ LED Indicator
- ⑦ RESET Key
- ⑧ Tablet key (Left)

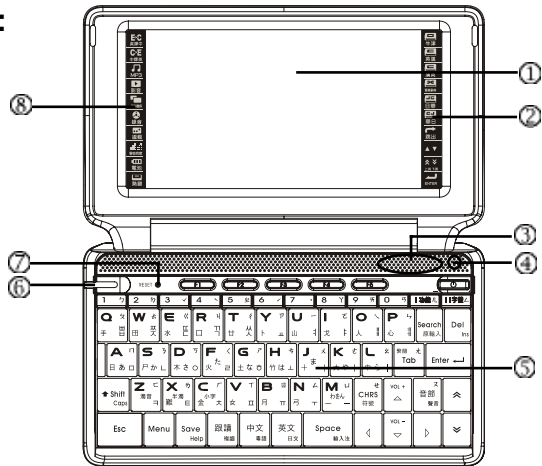

1.2 Reverse Side:

- ① Stylus
- ② USB Slot
- ③ SD/MMC Slot
- ④ Earphone Socket
- ⑤ Battery Cover

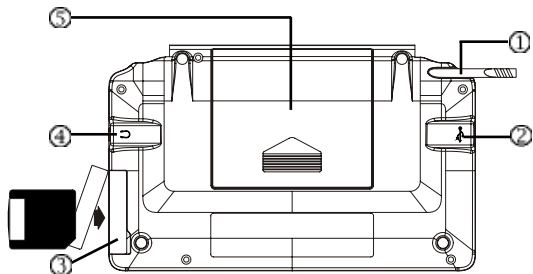

1.3 Key Description

- ① Chinese phonetic symbol
- ② Korean pinyin
- ③ Japanese kana
- ④ ChangJie
- ⑤ English letter

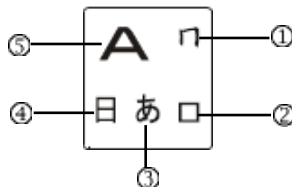



Introduction of the device

1.4 Touch Panel

	:E-C translation
	:C-E translation
	:MP3
	:Video
	:Illustrated Dictionary
	:Digital Recorder
	:Open the edit screen
	:Adjust sound and Brightness
	:Check battery power
	:Open My Favorite screen

	:Oxford Advanced Dictionary
	:English-Chinese Dictionary
	:Chinese-English Dictionary
	:Terminological Dictionaries
	:J-C Dictionary
	:C-J Dictionary
	:Function same as [ESC]
	:same as the Up/Down key
	:same as the Page Up/Down
	:Function same as [ENTER]

2. Keyboard

	❖ Power on/off
RESET ●	❖ RESET key
	❖ Select the corresponding main menu ❖ Function keys, same as [F1]~[F5] on the screen
	❖ Numeric key “1” ❖ Chinese phonetic symbol “ㄅ” ❖ The first tone of Pinyin input method ❖ Input symbol “!” with [SHIFT] key
	❖ Numeric Key “2” ❖ Chinese phonetic symbol “ㄆ” ❖ The second tone of Pinyin input method ❖ Input symbol “@” with [SHIFT] key
	❖ Numeric key “3” ❖ The third tone of phonetic/Pinyin input method ❖ Input symbol “#” with [SHIFT] key
	❖ Numeric key “4” ❖ The fourth tone of phonetic/Pinyin input method ❖ Input symbol “\$” with [SHIFT] key







Introduction of the device

	<ul style="list-style-type: none"> ❖ Numeric key “5” ❖ Chinese phonetic symbol “ㄅ” ❖ The light tone of Pinyin input method ❖ Input symbol “%” with [SHIFT] key
	<ul style="list-style-type: none"> ❖ Numeric key “6” ❖ The second tone of phonetic/Pinyin input method ❖ Input symbol “?” with [SHIFT] key
	<ul style="list-style-type: none"> ❖ Numeric key “7” ❖ The light tone of phonetic/Pinyin input method ❖ Input symbol “.” with [SHIFT] key
	<ul style="list-style-type: none"> ❖ Numeric key “8” ❖ Chinese phonetic symbol “ㄩ” ❖ Input symbol “*” with [SHIFT] key
	<ul style="list-style-type: none"> ❖ Numeric key “9” ❖ Chinese phonetic symbol “ㄉ” ❖ Input symbol “(” with [SHIFT] key
	<ul style="list-style-type: none"> ❖ Numeric key “0” ❖ Chinese phonetic symbol “ㄊ” ❖ Input symbol “)” with [SHIFT] key
	<ul style="list-style-type: none"> ❖ Select item “l” in the main menu ❖ Chinese phonetic symbol “ㄌ” ❖ Open “Function” menu, same as [Func] on the screen ❖ Hyphen “-” with [SHIFT] key
	<ul style="list-style-type: none"> ❖ Select item “ll” in the main menu ❖ Chinese phonetic symbol “ㄌ” ❖ Switch font size on the index and explanation screen of dictionaries and detail view screen of PIM, provides magnifying the highlighted words. ❖ With [SHIFT] key, input symbol “.” in English input mode; input space mark in Japanese input mode; input decimal point in calculator
	<ul style="list-style-type: none"> ❖ English letter “A” ❖ Chinese phonetic symbol “ㄐ” ❖ ChangJie/Simplified ChangJie input method “日”



Introduction of the device

	<ul style="list-style-type: none"> ❖ Japanese kana in “あ” line ❖ Korean Pinyin “ㅁ” ❖ Mathematical sign: logarithm ❖ AM setting in 12-hour system
	<ul style="list-style-type: none"> ❖ English letter “B” ❖ Chinese phonetic symbol “ㄅ” ❖ ChangJie/Simplified ChangJie input method “月” ❖ Korean Pinyin “ㅍ” ❖ Mathematical sign: factorial (!)
	<ul style="list-style-type: none"> ❖ English letter “C” ❖ Chinese phonetic symbol “ㄆ” ❖ ChangJie/Simplified ChangJie input method “金” ❖ Japanese input method: small character ❖ Korean Pinyin “ㅊ” ❖ Mathematical sign: scientific notation method
	<ul style="list-style-type: none"> ❖ English letter “D” ❖ Chinese phonetic symbol “ㄑ” ❖ ChangJie/Simplified ChangJie input method “木” ❖ Japanese kana in “さ” line ❖ Korean Pinyin “ㅇ” ❖ Mathematical sign: square root
	<ul style="list-style-type: none"> ❖ English letter “E” ❖ Chinese phonetic symbol “ㄨ” ❖ ChangJie/Simplified ChangJie input method “水” ❖ Korean Pinyin “ㄷ” and “ㅌ” (with [SHIFT] key) ❖ Mathematical sign: square
	<ul style="list-style-type: none"> ❖ English letter “F” ❖ Chinese phonetic symbol “ㄣ” ❖ ChangJie/Simplified ChangJie input method “火” ❖ Japanese kana in “た” line ❖ Korean Pinyin “ㅍ” ❖ Mathematical sign: Y root of X







Introduction of the device

<div style="border: 1px solid black; padding: 5px; width: fit-content; margin: auto;"> G 尸 土 乃 ㇿ </div>	<ul style="list-style-type: none"> ❖ English letter “G” ❖ Chinese phonetic symbol “尸” ❖ ChangJie/Simplified ChangJie input method “土” ❖ Japanese kana in “乃” line ❖ Korean Pinyin “ㇿ” ❖ Mathematical sign: X power of 10
<div style="border: 1px solid black; padding: 5px; width: fit-content; margin: auto;"> H ㇿ 竹 是 土 </div>	<ul style="list-style-type: none"> ❖ English letter “H” ❖ Chinese phonetic symbol “ㇿ” ❖ ChangJie/Simplified ChangJie input method “竹” ❖ Japanese kana in “は” line ❖ Korean Pinyin “土” ❖ Mathematical sign: [MC] (clear memory numerals)
<div style="border: 1px solid black; padding: 5px; width: fit-content; margin: auto;"> I ㇿ 戈 卜 </div>	<ul style="list-style-type: none"> ❖ English letter “I” ❖ Chinese phonetic symbol “ㇿ” ❖ ChangJie/Simplified ChangJie input method “戈” ❖ Korean Pinyin “卜” ❖ Mathematical sign: subtraction ❖ Logical operator “not” in scientific calculator with [SHIFT] key
<div style="border: 1px solid black; padding: 5px; width: fit-content; margin: auto;"> J ㇿ 十 ㇿ ㇿ </div>	<ul style="list-style-type: none"> ❖ English letter “J” ❖ Chinese phonetic symbol “ㇿ” ❖ ChangJie/Simplified ChangJie input method “十” ❖ Japanese kana in “ま” line ❖ Korean Pinyin “ㇿ” ❖ Mathematical sign: [MR] (display numerals)
<div style="border: 1px solid black; padding: 5px; width: fit-content; margin: auto;"> K ㇿ 大 ㇿ ㇿ </div>	<ul style="list-style-type: none"> ❖ English letter “K” ❖ Chinese phonetic symbol “ㇿ” ❖ ChangJie/Simplified ChangJie input method “大” ❖ Japanese kana in “ㇿ” line ❖ Korean Pinyin “ㇿ” ❖ Mathematical sign: [M-] (memory subtract)







Introduction of the device

	<ul style="list-style-type: none"> ❖ English letter “L” ❖ Chinese phonetic symbol “么” ❖ ChangJie/Simplified ChangJie input method “中” ❖ Japanese kana in “ら” line ❖ Korean Pinyin “ㄹ” ❖ Mathematical sign: [M+] (memory add)
	<ul style="list-style-type: none"> ❖ English letter “M” ❖ Chinese phonetic symbol “ㄩ” ❖ ChangJie/Simplified ChangJie input method “一” ❖ Japanese kana “わ”、“を”、“ん”; Japanese long tone with [SHIFT] key ❖ Korean Pinyin “—” ❖ Mathematical sign: [AC] (clear memory numerals and calculating steps)
	<ul style="list-style-type: none"> ❖ English letter “N” ❖ Chinese phonetic symbol “ㄨ” ❖ ChangJie/Simplified ChangJie input method “ㄣ” ❖ Korean Pinyin “ㄒ” ❖ Mathematical sign: clear numerals
	<ul style="list-style-type: none"> ❖ English letter “O” ❖ Chinese phonetic symbol “ㄛ” ❖ ChangJie/Simplified ChangJie input method “人” ❖ Korean Pinyin “ㅍ” and “ㅑ” (with [SHIFT] key) ❖ Mathematical sign: addition ❖ Logical operator “xor” in scientific calculator with [SHIFT] key
	<ul style="list-style-type: none"> ❖ English letter “P” ❖ Chinese phonetic symbol “ㄨ” ❖ ChangJie/Simplified ChangJie input method “心” ❖ Korean Pinyin “ㅍ” and “ㅑ” (with [SHIFT] key) ❖ Mathematical sign: positive/negative ❖ PM setting in 12-hour system









Introduction of the device

	<ul style="list-style-type: none"> ❖ English letter “Q” ❖ Chinese phonetic symbol “夕” ❖ ChangJie/Simplified ChangJie input method “手” ❖ Korean Pinyin “夕” and “出” (with [SHIFT] key) ❖ Mathematical sign: inverse
	<ul style="list-style-type: none"> ❖ English letter “R” ❖ Chinese phonetic symbol “ㄹ” ❖ ChangJie/Simplified ChangJie input method “ㄹ” ❖ Korean Pinyin “ㄱ” and “ㄱ” (with [SHIFT] key) ❖ Mathematical sign: Y power of X
	<ul style="list-style-type: none"> ❖ English letter “S” ❖ Chinese phonetic symbol “ㄱ” ❖ ChangJie/Simplified ChangJie input method “尸” ❖ Japanese kana in “ㄱ” line ❖ Korean Pinyin “ㄷ” ❖ Mathematical sign: exponential constant (e=2.71828...)
	<ul style="list-style-type: none"> ❖ English letter “T” ❖ Chinese phonetic symbol “ㄷ” ❖ ChangJie/Simplified ChangJie input method “ㄱ” ❖ Korean Pinyin “ㄷ” and “ㄷ” (with [SHIFT] key) ❖ Mathematical sign: ° (degree), ' (minute), " (second)
	<ul style="list-style-type: none"> ❖ English letter “U” ❖ Chinese phonetic symbol “ㄷ” ❖ ChangJie/Simplified ChangJie input method “山” ❖ Korean Pinyin “ㄷ” ❖ Mathematical sign: multiplication ❖ Logical operator “or” in scientific calculator with [SHIFT] key









Introduction of the device

	<ul style="list-style-type: none"> ❖ English letter “V” ❖ Chinese phonetic symbol “ㄩ” ❖ ChangJie/Simplified ChangJie input method “女” ❖ Korean Pinyin “兀” ❖ Mathematical sign: PI ($\pi=3.14159\dots$)
	<ul style="list-style-type: none"> ❖ English letter “W” ❖ Chinese phonetic symbol “去” ❖ ChangJie/Simplified ChangJie input method “田” ❖ Korean Pinyin “ㄨ” and “ㄨ” (with [SHIFT] key) ❖ Mathematical sign: X power of e
	<ul style="list-style-type: none"> ❖ English letter “X” ❖ Chinese phonetic symbol “ㄨ” ❖ ChangJie/Simplified ChangJie input method “難” ❖ Japanese input method: half-voiced sound ❖ Korean Pinyin “ㄣ” ❖ Scientific plotting sign: X ❖ Scientific calculation: angle conversion
	<ul style="list-style-type: none"> ❖ English letter “Y” ❖ Chinese phonetic symbol “ㄩ” ❖ ChangJie/Simplified ChangJie input method “卜” ❖ Korean Pinyin “ㄩ” ❖ Mathematical sign: division ❖ Logical operator “and” in scientific calculator with [SHIFT] key
	<ul style="list-style-type: none"> ❖ English letter “Z” ❖ Chinese phonetic symbol “ㄣ” ❖ Japanese input method: voiced sound ❖ Korean Pinyin “ㄣ” ❖ Scientific calculation: mode conversion
	<ul style="list-style-type: none"> ❖ Open the “Search Engine” screen ❖ Search the words/sentences/phrases/all of the keyword in the explanation screen

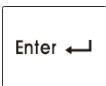





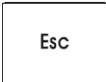

Introduction of the device

	<ul style="list-style-type: none"> ❖ Access the search screen of “Name Card, Memorandum, Schedule, To Do List, Anniversary, Class Schedule, Income & Expense” in PIM; access multi-dictionaries search screen except above ❖ Return to the original inputting screen with [SHIFT] key
	<ul style="list-style-type: none"> ❖ Delete a letter or the selected string ❖ Delete the selected items, same as [Del] on the screen ❖ Switch the editing mode with [SHIFT] key
	<ul style="list-style-type: none"> ❖ Switch focus on some screens ❖ Switch the main menu between traditional and simplified character ❖ Chinese phonetic symbol “尤” ❖ Open/Close preview screen when searching in dictionaries with [SHIFT] key
	<ul style="list-style-type: none"> ❖ Confirm the current action ❖ Move the cursor to the next line to input data ❖ Mathematical sign: equal to [=] to calculate result
	<ul style="list-style-type: none"> ❖ Combine with other keys ❖ Temporarily lock the keyboard for inputting capital letters in English ❖ Press [SHIFT] twice to lock the keyboard for inputting capital letters in English
	<ul style="list-style-type: none"> ❖ Chinese phonetic symbol “世” ❖ Input symbols (Notes: you should first switch to other Chinese input methods when using the Chinese phonetic symbol input method, then to input symbols)
	<ul style="list-style-type: none"> ❖ Chinese phonetic symbol “又” ❖ Pronounce syllable by syllable for words on the explanation screen of dictionaries ❖ Set volume, speed and Brightness with [SHIFT] key; Set Mute function

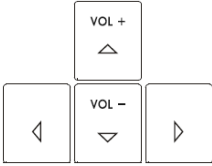

Introduction of the device

	<ul style="list-style-type: none">❖ Exit from the current function or return to the previous screen
	<ul style="list-style-type: none">❖ Switch five languages in the main menu❖ Directly return to the main menu
	<ul style="list-style-type: none">❖ Save the messages❖ Save items on the explanation screen of dictionaries, Vocabulary and Multi-language Dialogue for Review and Test❖ Show the on-line help messages with [SHIFT] key
	<ul style="list-style-type: none">❖ Read after the device (On the explanation screen of dictionaries, Multi-language Dialogue, Interactive English, etc.)❖ Repeat function with [SHIFT] key
	<ul style="list-style-type: none">❖ Pronounce Chinese❖ Pronounce Cantonese with [SHIFT] key
	<ul style="list-style-type: none">❖ Pronounce English❖ Pronounce Japanese with [SHIFT] key
	<ul style="list-style-type: none">❖ Input a space❖ The first tone of phonetic input method❖ Confirm the first choice when inputting Chinese❖ Open input methods menu with [SHIFT] key
	<ul style="list-style-type: none">❖ Up direction key; move the cursor up or scroll a line up. Press [SHIFT] + Up direction key to turn the volume up❖ Down direction key; move the cursor down or scroll a line down. Press [SHIFT] + Down direction key to turn the volume down❖ Left direction key; move the cursor left or page left❖ Right direction key; move the cursor right or page right



Introduction of the device



- ❖ Page up
- ❖ View the previous data
- ❖ Page down
- ❖ View the next data

3. The Panel

- ① The touch panel possesses high penetrability.
- ② The product adopts 4.3 inch TFT screen.

4. Power Source

One of the following three power sources can be used.

- ① Rechargeable lithium battery: 3.7V/1050mAh
- ② Connect with PC via USB cable. (With charging function)
- ③ A power adaptor with DC output 5V/700mA.
 - * This power source can be used with operation ①.

4.1 Replacing Battery

Insert:

- ① Press [ON/OFF] to turn off the power.
- ② Remove the battery compartment cover.
- ③ Insert the battery into the compartment as right.
- ④ Close the battery compartment cover securely.

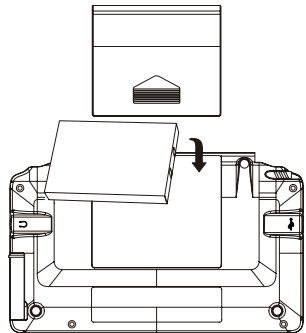

Remove:

Repeat the steps ① and ②. Then please remove the battery as instruction.



Introduction of the device

Notes:

- ❶ When the power is insufficient, please insert the USB cable or power adaptor to recharge the battery.
- ❷ If the screen of "LOADING..." appears repeatedly, this means the battery is no longer usable. Please get a new one.
- ❸ Personal data will be retained even if the device is out of power. Please turn the device off first, and then take out the battery 3 seconds later. Otherwise, data may be displayed incorrectly.

4.2 Recharging Battery

If you are the first time to use the device, please recharging battery first.

- ❶ Connect the device and PC with USB cable. It takes about 5 hours to fully recharge.
- ❷ Connect the device and power supply with the special adaptor. One end is inserted in the USB slot, the other is inserted in the electrical outlet. It takes about 3 hours to fully recharge.

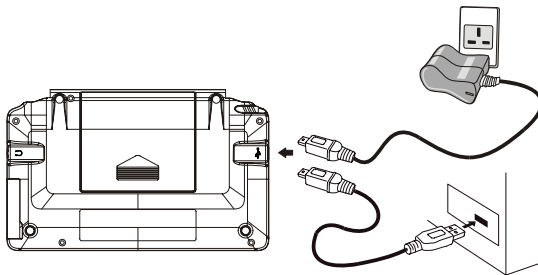

Notes:

The LED displays different colors in different situations:

- * green light ---> No battery or battery full recharged.
- * red light ---> Power is recharging with battery.

5. Initialization or RESET

When you turn on the device for the first time or RESET the device, you should set your device according to the following steps:



Introduction of the device

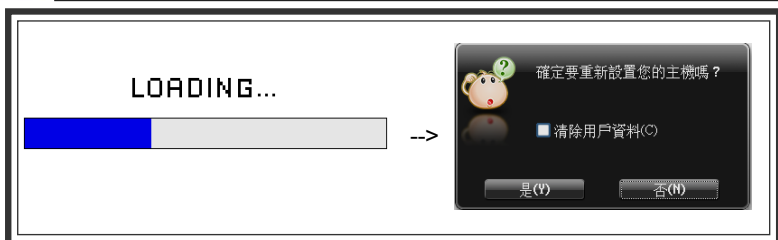

- * Select [N] to access the main menu.
- * Select [Y], system check the data of memory to return to the default values. Then entering the Date/Time Setting screen.

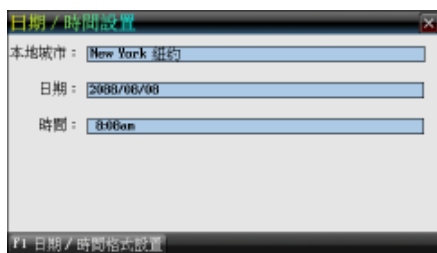
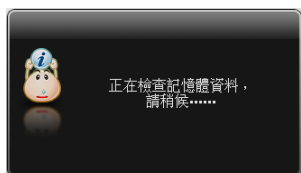

- * Tap [C] first, and then tap [Y] to clear all the data saved in the device. Then enter the Date/Time Setting screen.

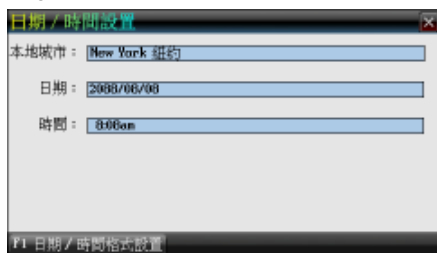



Introduction of the device

6. Introduction of the functions

Classical Desktop (Main Menu):

Search Engine district: EN

Function select district: DICT STUDY MULTI PIM SYS

Main manu of function select district: English-Chinese Dictionary, Chinese-English Dictionary, Oxford Advanced Learner's Dictionary, Britannica Concise Encyclopedia, Cambridge Encyclopedia, Terminological Dictionaries, English Collocations Dictionary, Example Dictionary, Slang Dictionary, Sentence Translation, Multi-Language Dictionary

Time: AM 08:10

Battery: [Battery Icon]

My favorite: [My Favorite Icon]

	Begin to search
	Select A – check the battery power Select B -- access the “World Time” (If plug in to an outlet , the icon of the district will become)
	Access to “My Favorite”
	Choose the 16 types of input method
	Upside picture -- unselected Downside picture -- selected “” -- Please log-in our website to download On-line Service
	Input the word which you want to search
	Choose the type of search



Introduction of the device

- ① In the main catalogue and the main menu screens:
 - * Press [Menu] to switch among English, Korean, Japanese, Spanish and Chinese modes. (Suit for Chinese learners)
 - * Press [TAB] to switch the main catalogue between simplified and traditional Chinese in Chinese catalogue.
- ② In the Main menus screens:
 - * Directly tap to select or press the corresponding numeric key to access function items.
- ③ In the function screens:
 - * Press [Menu] to return to the main menu.
 - * Press [ESC] to return to the previous menu.
 - * Press [SHIFT] first, and then press [SAVE] to display the on-line help.

6.1 Input Methods

The device provides several input methods, you can set your input methods in “SYS--Input Setting”.



: Data searching...



: Corresponding input methods.







: Tab to access Japanese Soft Keyboard.



: Tab to access handwriting recognition.

6.2 Handwriting Recognition

Whenever the icon  appears on the screen, handwriting recognition is available.

- ① Tap the icon.
- ② Tap  to switch to Chinese/English/Japanese/Korea input.
 - * Tap  to switch to corresponding soft keyboard.
 - * Tap  to open the on-screen symbol keyboard.



Introduction of the device

- * Tap to switch the single/three window for handwriting.
 - * Tap to switch to the function of full screen multiple handwriting.
 - * Tap to switch the single character recognition/multi character recognition under the writing mode of full screen.
- ③ Write in the handwriting area with stylus.
 - ④ The recognition result will be shown automatically in the standby area.
 - ⑤ Tap the desired character in the standby area by the stylus.
- * Tap to return to the keyboard input mode.
- ⑥ Handwriting areas 1, 2 and 3 are double window for handwriting, character will show in the handwriting areas 1, 2 and 3 separately. Handwriting areas 4 is a single window for handwriting.

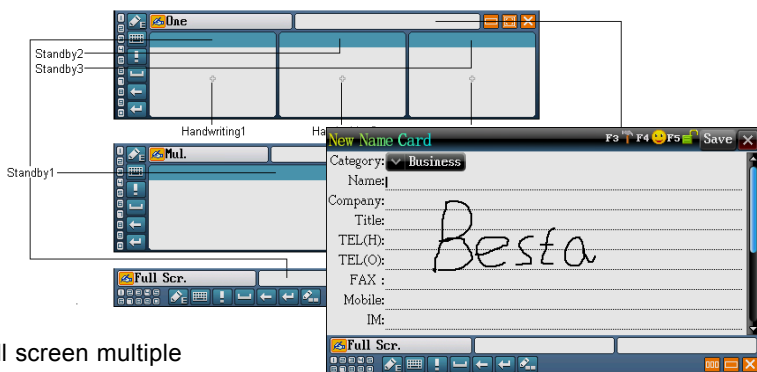

The full screen multiple handwriting window supports to tap other function keys when you are writing English words.



Introduction of the device

The recognition result

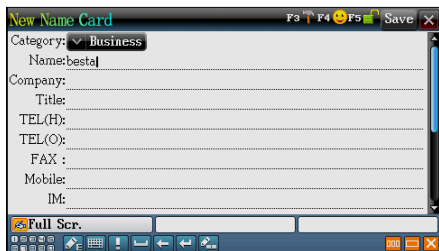

Notes:

- 1 The keyboard input method is also available when the English handwriting method is being used.
- 2 Please don't write the first stroke in the function area when you use the full screen multiple handwriting.
- 3 Handwrite pen up time can be set in <SYS--Handwriting Setting>.

6.3 USB Disk

Through USB cable, you can move, duplicate or delete data and add new file folder, etc.

- 1 Connect the device and PC by USB cable.
- 2 Please safely remove the USB cable from PC before unlink, then escape from "SYS--PC Link" in the device.

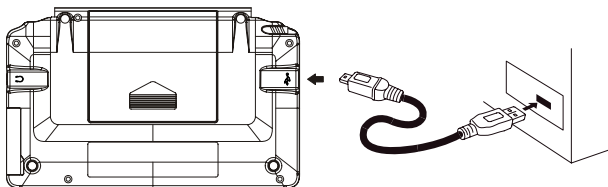

Notes:

- During operation:
- 1 Please make sure the device has enough power.
 - 2 Please not remove the link cable, otherwise the data will be lost or the device will be abnormal.
 - 3 Please don't insert/remove extra card.



Introduction of the device

6.4 Download Operation

The device provides automatic searching function and allows you to create new folder for data. The different file formats must be identified for easy retrieval, so please put the download data under the following path.

	List for automatic searching	List for reading by correct directory
DICT	--	Terminological Dictionary: \\STUDY\\PRODUCT
		Sentence Translation: \\STUDY\\LEARNING
		Extension Dictionary: \\STUDY\\EXTRADIC
STUDY	Interactive English	--
	English Proficiency Test	
	English Exercise	
	Vocabulary	
	Listening & Speaking classroom	
MULTI	Video	Text Browser : \\MULTI\\TEXT
	Animated Grammar	
	Animated Phrase	
	eBook	
	My Album	
	MP3	
	Games World	
Flash Player		
ASST	--	Calculator : \\APPS\\CALC

6.4.1 Automatic searching function

! Please don't remove the link cable, otherwise the data will be lost or other unknowable faults, and please make sure the device has enough power.

! During the process of data transmission, a red line on device port will show the state of transmission.

! Before removing the USB:

① Make sure the data transmission is finished.



Introduction of the device

- ② Then click  on PC to remove the USB safely.
- ③ Press [ESC] to escape from function of “SYS--PCLink”.

eg., Download the data of Interactive English to device:

Step 1:

Use USB cable to connect PC and device, and then enter the function of “SYS--PC Link”.

Device



PC

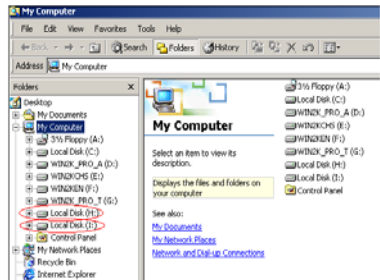

Step 2:

- ① Please insert the CD-ROM to PC.
- ② Duplicate data from CD-ROM to new storage of PC, and make sure memory of the storage is enough to store the data.

Step 3:

- ① Finish to download the data, please escape from the function of “SYS--PC Link”.
- ② Enter the screen of Terminological Dictionary, the device begins to search the download data.



Introduction of the device

Search the data



Open the Interactive English

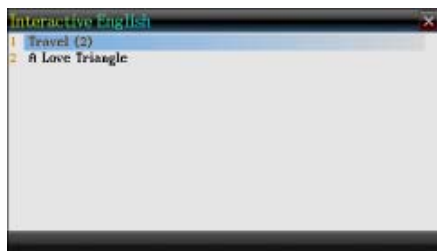

6.4.2 Create new folder for downloading data

eg., Download the data of Extension Dictionary to device:

Step 1 and step 2 are the same as step of "6.4.1".

Step 3

At first, enter the "SYS--File Management".





Introduction of the device

Then choose [C], enter catalogue of "STUDY"

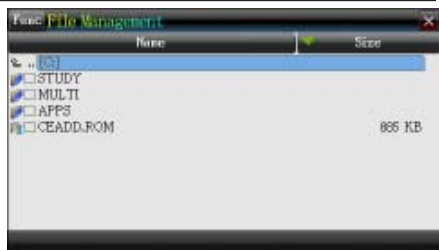

Tap "FUNC--2 New Folder"

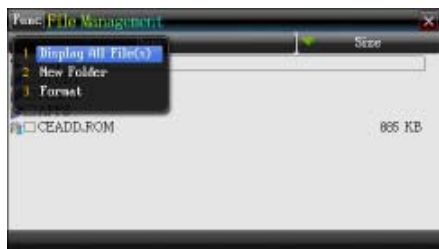

Input "EXTRADIC", then tap [ENTER]

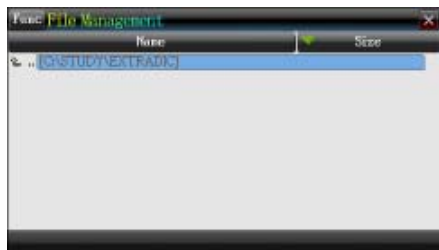

Duplicate two files to the new folder under the [C:\STUDY\EXTRADIC]

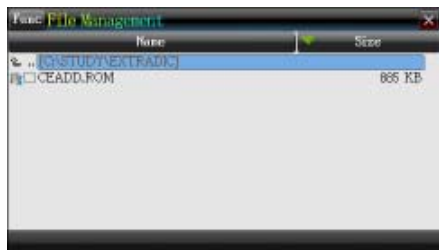



Introduction of the device

Enter the “Extension Dictionary”





DICT

Dictionary Summary

- ◆ Provides smart input and wildcard search.
- ◆ Provides searching function for all the words, sentences and phrases.
- ◆ Provides pronunciation, Visual Speech and preview window on the index screen, and provides history function and delete history function.
- ◆ Provides vowel of phonetic symbols marked in red.
- ◆ Provides 2 kinds of font sizes on the index screen, Provides 5 kinds of font sizes on the explanation screen, and provides magnifying/minifying the highlighted words.
- ◆ Cross search up to 30 layers.
- ◆ Highlight words on the explanation screen, and then tap [CHN-ENG] or [ENG-CHN] to access Sentence Translation with the highlighted words input.
- ◆ Can repeat and read after the device. The speed of pronunciation can be adjusted.
- ◆ Pronunciation in Mandarin, English and Cantonese. Pronunciation in Mandarin can pronounce word by word and provides function of Demo.
- ◆ Can pronounce syllable by syllable for English words.
- ◆ Some dictionaries provide function of stroke practicing.
- ◆ Provides function of human pronunciation.
- ◆ Allows to save data for Review and Test.

✕ English-Chinese Dictionary

- * Provides a wide coverage of English entries, provides example sentence, grammar, analysis (form, pronunciation, root, meaning, variation, synonym, antonym, relative words), component, makeword such data for reference.
- * Provides KK and DJ English phonetic symbols for selection.



DICT

✕ **Chinese-English Dictionary**

- * Covers an abundance of Chinese words and English explanations.

✕ **Oxford Advanced Learner's Dictionary**

- * Provides a wide coverage of English entries in the latest edition. Includes Total Library, Usages, Idioms, Verb Phrases, Prefix & Suffix, New-added Words, Basic Words.
- * Provides Chinese explanations, KK and DJ English phonetic symbols for selection and searching function.

✕ **Britannica Encyclopedia**

- * Covers abundant words, provides search mode of Chinese, English, Class Search, Map Search for searching.

✕ **Cambridge Encyclopedia**

- * Detailed content of the whole Cambridge Encyclopedia, Provides reference comparison.

✕ **Terminological Dictionaries**

- * Please download kinds of terminological dictionaries from our website.

✕ **English Collocation Dictionary**

- * Provides collocation words and phrases of words, provides Multi-layered search and cross search.

✕ **Example Dictionary**

- * Provides abundant example sentence searching and explanation of English.

✕ **Slang Dictionary**

- * Covers abundant common slang with detailed explanations in English, Korean, Chinese and Japanese, provides abounding example sentences.



DICT

✕ **Sentence Translation**

- * Allows to input Chinese or English to search for the translation results.
- * Provides built-in library and extension library for downloading.

✕ **Multi-Language Dictionary**

- * Provides 13 countries Dictionary, provides pronunciation and key words searching.

✕ **Extended Card**

- * Supports inserting Terminological Dictionaries Card and Memory Card to view the data of cards.

✕ **J-C/C-J Dictionary**

- * Provides Japanese-Chinese Dictionary, Chinese-Japanese Dictionary, Foreign Words, Detailed Kanji, Idioms & Proverbs. Provides Common Words, Practical Nouns, Reference to search. Provides Fifty Phonemes, Speak Japanese, Search in sentences , Graded Vocabulary to search and study.
- * Provides strokes study of Japanese.

✕ **Chinese Dictionary**

- * Provides classified searching of Wordbook, Idioms and Dictionary, and provides strokes study.
- * Covers abundant Chinese phrases and idioms, provides detailed explanations of Chinese characters, radical strokes on the explanation screen, which includes Radical, Remnant Stroke(s), Total Strokes, Internal Code, ChangJie and BoShiAmy.

✕ **Synonym-Antonym Dictionary**

- * Provides searching function of example sentence, grammar, analysis, word component, make word, multimedia information and searching of word pattern, word root, word pronunciation, word meaning, Synonym word, Antonym word, relative word.



DICT

✕ **Word Component**

- * Provides analysis of word, prefix, root, suffix, and explanation, pronunciation for 6000 words.

✕ **E-C-J-K Dictionary**

- * Includes function of searching in E-C-J-K Dictionary, pronunciation in English/Chinese/Japanese/Korea, function of repetition and Read after the Device.
- * Provides function of “Practical Nouns, Daily Conversation, Travel Dialogues, Trade English, C-J-E-K Conversation”.

✕ **Search Engine**

- * Provides input English, Chinese, Japanese, Korea words. Allows to search words in scale of word/example sentence/phrase/all.

✕ **Extension Dictionary**

- * Allows to download your desired dictionaries to extend dictionaries of this device.

✕ **DIY Dictionary**

- * Allows to duplicate, modify, delete the build-in data to extend the dictionaries of this device.

✕ **Chinese Learning**

- * Provides function of Strokes, Radicals, Characters Learning, PinYin, Characters Structure, Chinese Classifier, provides function of human pronunciation and example sentence studying.

✕ **Idioms Dictionary**



- * Provides synonym, antonym, derivation such relative data.





DICT

1. Dictionary Index

After dictionary function is accessed, the index screen of all entries will appear first. On this screen, you can press the Page Up/Down key for search or input words to search explanations.

- * Tap  to switch single/double windows.
- * Tap  or press [SHIFT] then press [SPACE] to display the input methods for select.
- * Tap  to open handwriting input method.
- * Tap [字體] to switch 2 kinds of font sizes.
- * Tap [SHIFT] key with page up/down key to go to the first page or last page of index screen.
- * In English index screen, directly input the English words to search.
- * In English index screen, press [英文 / 日文] to pronounce English.
- * In Chinese index screen, choose the corresponding input method to input the Chinese character to search.
- * In Chinese index screen, press [中文 / 粵語] to pronounce Chinese.
- * Tap [ENTER] key to enter the explanation screen.
- * Tap [ESC] to return to the main menu.
- * Provides multi-dictionaries for all dictionaries.
- * Secondary search and wildcard search are not available in some dictionaries. Please refer to the introduction of dictionary.

Notes:

When the explanation contents are highlighted, tap   to access Sentence Translation.

1.1 History

Tap or press [F5History] to view the words that have been looked up recently (Up to 200 words can be recorded). Press [DEL] to delete the records one by one.



DICT

1.2 Classification

If available, tap [F1Classification] to display the list of categories. Tap or press the numeric key to select item.

e.g., Oxford Advanced Learner's Dictionary

1.3 Language Selection

Tap [F1CHN/ENG] to switch between Chinese and English display modes. Tap [F1Language] to select a corresponding language when several languages are provided.

e.g., Cambridge Encyclopedia







e.g., E-C-J-K Dictionary--E-C-J-K Dictionary

2. Dictionary Explanation

Input words to be looked up and access the explanation screen.

- * Press the Page Up/Down key to look up the previous/next explanation.
- * Press [SHIFT] first, and then press the Page Up/Down key to view the explanation of the current word on the previous/next page.
- * Provides pronunciation of Chinese, Cantonese, English, Japanese.
- * Provides repetition and reading after the device for practice.
- * 5 kinds of font sizes can be switched, and provides magnifying the highlighted words.
- * Can cross search, search in multi-dictionaries and Sentence Translation for the selected words, the cross search layer up to 30.

<Some dictionaries will provide following function>:

- * Provides vowel of phonetic symbols marked in red, and provides syllable pronunciation for English words.
- * Provides    three kinds of explanation to be switched.
- * Provides   to link search for the current word.
- * Provides   phonetic symbols for selection.



DICT

- *  indicates that the current word is human pronunciation.
- * Provides example sentences, multimedia, etc., for reference.
- * Provides strokes study when you download the function of strokes.

2.1 Font Size

- * In explanation screen, press [字體] to switch 5 kinds of font sizes,
- * In explanation screen, press [字體] to magnifying/minifying the highlighted words.

Press [字體] to magnifying/
minifying the highlighted
words

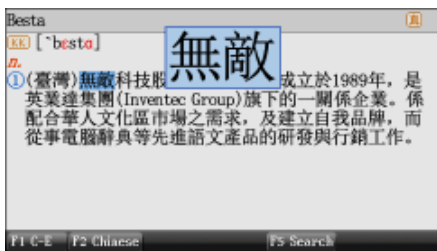

2.2 Saving Data

Press [SAVE] to save words or sentences for review and test. Only the saved data can be displayed in “STUDY--Review and Test”.

2.3 Pronunciation

In the explanation screen :

- * Press [英文 / 日文] to listen to English pronunciation.
- * Press [中文 / 粵語] to listen to Chinese pronunciation.
- * Press [音節] to listen to syllable pronunciation.
- * Press [SHIFT] once and press [中文 / 粵語] to listen to Cantonese pronunciation.
- * Press [SHIFT] once and press [英文 / 日文] to listen to Japanese pronunciation.
- * Press [ESC] to stop pronunciation.
- * Tap  or press [SHIFT] once and press [音節 / 聲音] to set volume and speed.



DICT

2.4 Repetition

Repetition is available on the explanation screen. Press [SHIFT] once, and then press [跟讀 / 複讀] once, the device will repeat the current Chinese/English headwords. (The times of repetition can be set in “SYS--Sound Setting”).

2.5 Read after the Device

Read after the device is available on the explanation screen. Press [跟讀 / 複讀] once to practice Chinese/English pronunciations. (Recording time is about 5 seconds.)

2.6 Pronounce Chinese words word by word

The device can pronounce Chinese word by word, it make you easy to learn pronunciation of Chinese words. Please set the function in the “SYS--Sound Setting”.

“Visual Speech” of Chinese words,

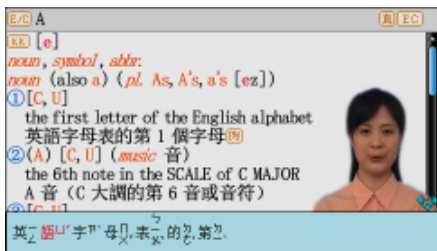

press left/right/up/down key
or draw the portrait by stylus
to moving the portrait

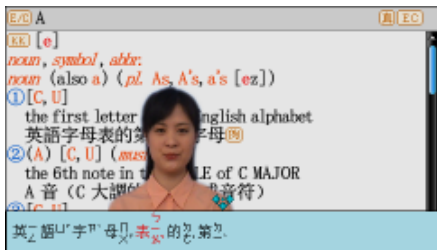



DICT

Notes:

↔/↔/↔/↔ key show the moving scope of the portrait of screen, ↔/↔ key to move the position of the portrait, ↘ key show moving the portrait to the downside of screen to close the caption, ↗ key show opening the caption.

3. Strokes

Device provides the function of strokes, there will be the [F4 筆順] button in the explanation screen of Chinese Dictionary and J-C/C-J Dictionary--Detailed Kanji. Strokes function provides strokes demonstration and practice function to help user study strokes of words.

e.g., Strokes practice of “或” in Chinese Dictionary
Strokes practice screen



4. Searching Data

Provides several search methods to help users.

index screen:

1. Smart input search
2. Wildcard search (Only available for English)
3. Cross search
4. Secondary search

explanation screen:

1. Multi-layered search
2. Other data search
3. Search
4. Sentence Translation

4.1 Smart Input Search

Just input the first one or several letters, you can find the desired words or phrases.



DICT

There are 3 kinds of methods:

- ① Input the first or first several letters of a word, or mark a word to be looked up, and then press [ENTER] to confirm.
As for Chinese character, input the first one or several Chinese characters to be looked up, and then press [ENTER] to confirm.
- ② Double tap the word or character to be looked up.
- ③ Press [1]~[0], [I] to select the corresponding word or character.

4.2 Wildcard Search (Only Available for English)

To look up a word that you are not sure of spelling, input all the letters you know, and then replace the unknown letters with “?” or “*”.

Steps:

- ① Input the English letters that you are sure of.
- ② Input unknown letters with “?” or “*”.
- ③ Press [ENTER], the list of words matching with your input will be displayed.
 - * Press the Page Up/Down key to look up.
 - * Press the Up/Down key to move the cursor to select words.
- ④ Press [1]~[0], [A], [B], [C], double tap the word or press [ENTER] to search.

Notes:

“?” stands for an unknown letter; “*” stands for a string of unknown letters.

4.3 Cross Search

When the current dictionary does not contain the word or character you want to look up, the device will transfer to other dictionaries (Oxford Advanced Learner’s Dictionary, English-Chinese Dictionary and DIY Dictionary). If the word or character is available in other dictionaries, it will display the explanation.



DICT

The cross search order:

English word: Oxford Advanced Learner's Dictionary -> English-Chinese Dictionary -> DIY Dictionary -> Search Engine.
Chinese character: DIY Dictionary -> Search Engine.

Notes:

If the corresponding Extension Dictionary of a certain dictionary has been downloaded, the device will search for words in the Extension Dictionary first, and then others.

4.4 Secondary Search

If the word you input is not found, please check your spelling, or that this words not covered in this dictionary. The device will provide 2 kinds of searching methods and 1 recording method:

Spelling Check -- displays the list of words similar in spelling.

The Nearest Word -- displays the nearest word in order.

Add New Word -- add the unfound word into DIY Dictionary.

Steps:

- ① Input English word, then press [ENTER] to search.
- ② Press the corresponding numeric keys to search.
 - * If "1 Spelling Check" is selected, press the Up/Down key to select the desired word, and then press [ENTER] to confirm.
 - * If "2 The Nearest Word" is selected, it will display the explanation of the nearest word.
 - * If "3 Add New Word" is selected, you can add the word into DIY Dictionary.

4.5 Multi-layered Search (Search on the Explanation Screen)

Multi-layered Search led you cross search the unfamiliar words or phrases. Please choose the words, then open the C-E Dictionary, Chinese



DICT

Dictionary or E-C Dictionary, Oxford Advanced Learner's Dictionary or other Dictionaries to search. The number of the layer will be displayed at the top right corner.

- ① On the explanation screen, highlight the Chinese character(s) or English word(s) to be looked up.
 - * By the stylus:
Highlight and drag word(s) by the stylus. Press [ESC] or tap anywhere on the screen except the highlighted area to cancel the highlight.
 - * By the keyboard:
Press the Right key to locate the cursor. Move the cursor to the word, tap [F3Mark] to fix the cursor, and then press the direction key to set the range. Tap [F3relax] to cancel.
- ② Press [ENTER] to search or press [F1], [F2], [F5] to search in the corresponding dictionaries.
 - * [F1] and [F2] provide search in the commonly used dictionaries. [F5] is the word bank. The function of [F1] is the same as that of [ENTER].
- ③ Press [ESC] to return to the previous screen.

5. Search Engine

Search Engine can search for the input data accurately and efficiently.

The input screen:

- * Choose the scale of searching: Words/Sentences/Phrases/All.
- * Tap [F5 Dictionary Setting] to select the scale of searching.
- * Tap [Search] or press [ENTER] to the result of searching.

Search Engine screen





DICT

e.g., searching for the sentences and phrases of the word “calm”

Search sentences of the word



Search phrases of the word

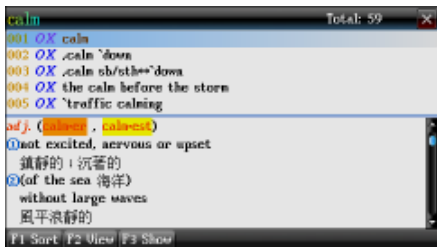

When you use the Multi-layered Search, please tap the [F5 Search] to access the function of searching, operate as the following picture:

Search “calm” in Oxford
Advanced Learner’s
Dictionary

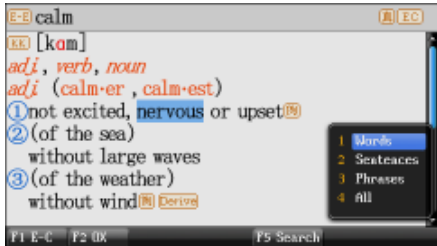

Tap “Words”











DICT

6. Sentence Translation

Function of Sentence Translation:

- ① Input content you want to translate, then press [ENTER] to search for the translation result.
 - * Chinese -- input at most 200 characters include space and punctuation.
 - * English -- input at most 200 letters includes space.
 - * To contents below which include but not confine within, may not offer the full translation.
 - Proper noun, e.g., Name or Place name;
 - Special term or uncommon words;
 - Idiom, slang, proverbs or other sentence with metaphor;
 - Spoken language or genuine vocabulary.
- ② Tap / or click [F4CHN-ENG]/[F4ENG-CHN] to switch between Chinese and English input modes. When switching the mode, the content in the editing zone will be cleared at the same time.
- ③ Tap [F5History] to view the saved translation; press [DEL] to delete the records one by one. Pressing [SAVE] on the input screen and the explanation screen to save data, but it isn't available on the reference screen.
- ④ When there is no downloaded extension library, press [F1] or tap " Reference" to unselect or select reference sentences library. When there is downloaded extension library, press [F1]/[F2] or tap " Built-in Lib"/" Extension Lib" to unselect or select built-in Library/Extension Library.
- ⑤ Tap  to open the input methods for selection, press [符號] to open the symbol input methods for selection; when the Chinese Phonetic Symbols input method is used, the Chinese symbol can be opened by switching to other input methods.
- ⑥ If the libraries are selected, [F1Reference] will be displayed on the



DICT

translation screen to provide example sentences of Oxford Library, Besta Library and Extension Library (if available).

- * [F1CHN/ENG] -- switch between Chinese and English.
- * [F2CHN VS ENG] -- view the comparison between English and Chinese.

- ⑦ Tap / or press the Page Up/Down key to view other example sentences.
- ⑧ In the translation screen, press the pronunciation keys to pronounce in English or Chinese, you can cross search the unknown words in the corresponding dictionaries.

Take “我決定今年暑假出國旅遊！” as example

No downloaded Extension
Library

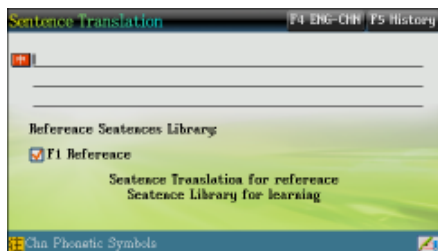

Input content (With Extension
Library)

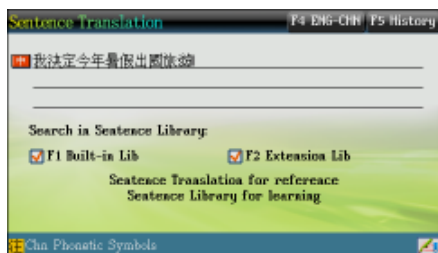



DICT

Switch to other input method



Tap [符號] key to select “!”

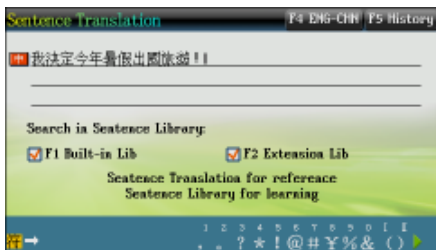

Then tap [ENTER]

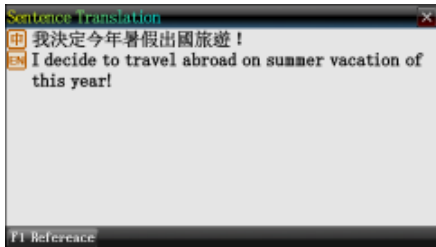

Tap [F1Reference]

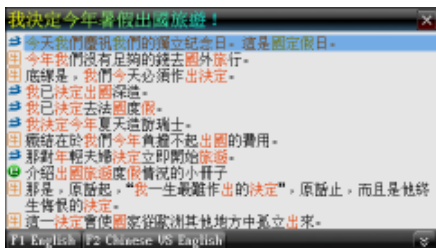



7. Chinese Learning

Chinese Learning provides function of PinYin, Characters Structure, Strokes, Radicals, Pronunciation, Strokes practicing and Chinese Classifier, helping users learning Chinese Comprehensively

The index screen of Chinese Learning



Strokes practicing function of Strokes



Radicals strokes practicing of Radicals





DICT

Function of Example Sentence,
Demonstration, Write,
structure of Characters Learning



Visual Speech of phonetic
symbol of Pin Yin

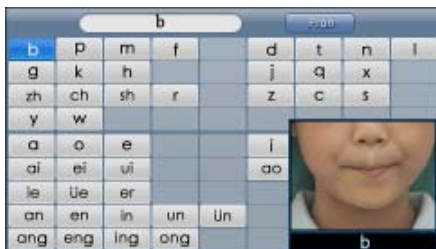

Characters Structure



Chinese Classifier

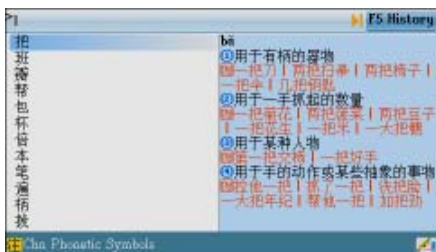



STUDY

Study Summary

- ◆ Language study series help you to learn English through dialogue, scene, simulation, word component, etc.
- ◆ English study series provide listening, speaking, reading and writing practice.
- ◆ Kinds of study tools are available for downloading.

✕ Multi-Language Dialogue

- * Provides abundant conversation in multi-language.
- * Provides 17 kinds Languages of 13 countries, and you can update by website downloading; synchronously display Chinese/English/ Japanese/Korean/a download language to contrast.
- * Provides key words searching, supports cross searching, the cross search up to 30 layers.
- * Provides human pronunciation and playing dialogue function to study.

✕ Interactive English

- * Includes dialogues on a variety of occasions, which can be downloaded and updated from our website.
- * Provides human pronunciation, read after the device, role play.

✕ English Proficiency Test

- * Provides GEPT Listening, GEPT Reading, simulated exams and practice room .
- * Updated database can be downloaded from our website.

✕ English Exercise

- * Allows to download data through PCLink from our website.

✕ Sentence Pattern Classroom

- * Provides 419 kinds of sentence patterns in 18 classifications and detailed analysis and example sentences.



STUDY

✕ Vocabulary

- * Provides words of Elementary School, Junior High School, Senior High School, College, TOEFL, GRE, GMAT, IELTS and Level I~VI words to search. Provides five kinds recite methods: view, remember, recall, spell, review.
- * Provides example sentences, usages and multimedia data on the explanation screen for reference.

✕ Listening & Speaking Classroom

- * Provides ABC Pronunciation, Reading Studio, Audio Studio and Baby American English. Provides capital/lower case, strokes and examples for search.

✕ Phonetic Symbol Demo

- * Provides standard pronunciation and key point in pronunciation for vowels and consonants.
- * Provides phonetic symbol demo and setting the repeat times.

✕ Review and Test

- * Allows to review and test the words saved in English-Chinese Dictionary, Oxford Advanced Learner's Dictionary, Chinese-English Dictionary, Chinese Dictionary, J-C/C-J Dictionary, Foreign Words and Kanji Index Dictionary, and sentences saved in Multi-language Dialogue. Besides, English-Chinese and Oxford tests are provided.
- * Provides Vocabulary, Word Browser, Choice, Sentence Making and Sentence Review to improve English.

✕ Mainland-Taiwan Differences

- * Provides abundant words of Mainland and Taiwan, helping users to study the differences between the words of Mainland and Taiwan.
- * Translates the words of Mainland and Taiwan to English and Korean, provides function of searching.



STUDY

1. Language Study Series

- * Take “Interactive English” for example:

Interactive English provides dialogues and role plays to help you quickly master vocabularies, example sentences and usages. The device will automatically search the downloaded data.

Data select list



Situation



Contents play

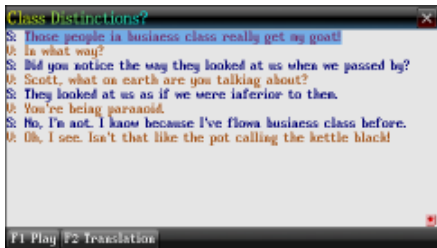



STUDY

Play + translation

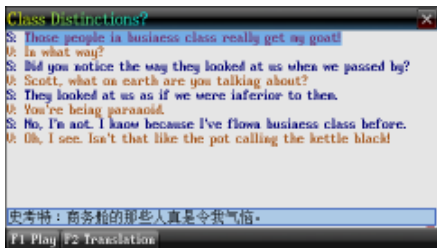

2. English Study Series

* Take "Phonetic Symbol Demo" for example:

Phonetic Symbol Demo provides standard phonetic symbol pronunciation with key point and example words. Provides demo of phonetic symbols, and the times of demo can be set in <Sys--Sound Setting>.

- * Allows to switch among vowel, consonant and special phonetic symbols.
- * Tap [F1Pron.] to listen to all the phonetic symbols continuously; tap the numeric keys at the end of every line to listen to syllable pronunciation for the current line.
- * Tap [F2Demo] to open (🗿)/close (😄) demo of phonetic symbols.
- * Tap [F5To D.J./ To K.K.] to switch between K.K. and D.J. pronunciations.
- * Press the Up/Down key, or press the Page Up/Down key to select phonetic symbols, and then press [ENTER] to view details.

K.K. phonetic symbols

Vowel	Consonant	Special	
[i]	legal	female	detail
[r]	skill	middle	little
[e]	tail	wait	afraid
[c]	small	better	success
[a]	stamp	bad	fat
[o]	rock	hot	stop
[A]	sun	fun	num
[o]	early	earth	learn

F1 Pron. F2 Demo F5 To D.J.



STUDY

Demo is open

	Vowel	Consonant	Special	
[i]	legal	female	detail	1
[ɪ]	skill	middle	little	2
[e]	tail	wait	afraid	3
[ɛ]	snell	better	success	4
[æ]	stamp	bad		5
[a]	rock	hot		6
[ʌ]	sun	fun		7
[ɔ]	early	earth		8

F1 Pron. F2 Demo F5 To D.J.

* Take “Listening & Speaking Classroom” for example:

Listening & Speaking Classroom provides listening, speaking, reading, writing and dialog to improve your English. The device will automatically search the downloaded data.

Pronunciation of example word

ABC Pronunciation

B b bird	
--------------------	--

Contents of Reading Studio

Human Fly

On May 26, 1977, George Willig traveled to the top of the 1,350-foot-tall World Trade Center in New York City. He did not take the elevator, however. Instead, like a human fly, George Willig climbed the outside of the immense 110-story building. His climb, which began at 6:30 a.m., took three and a half hours to finish. At the top, Willig was greeted by both police and reporters. Some of the police officers asked him for his autograph. Then they wanted to put him in jail and charged him with violation of law for climbing the building without a permit. Furthermore, the city also planned to sue him for a quarter of a million dollars. The amount, the police department reported, would pay the costs of rushing special equipment and eighty police officers in order to save him. By the next day, city officials had re-evaluated the situation.

F1 C-E Comparison F2 Choice F3 Test F4 Write



STUDY

Single Exercise of Audio Studio



Read Pictures by Words of
Baby American English





Multi

Multi Summary

- ◆ Multimedia study series allow to download data through PCLink from our website.
- ◆ Animated study series help you to learn English through words, grammar, phrases, cartoons, etc.
- ◆ Provides amusing functions of Games World, My Album, eBook.

✕ Video

- * Supports lots of media file types.
- * Provides function of Repetition, Read after the Device and cross search when video plays the studying film.

✕ Animated Grammar

- * Helps to understand grammars through animation stories.
- * Includes practice of Grammar Selections, Grammar Collections and Usual Grammar Mistakes.
- * Allows to cross search in corresponding dictionaries, allows to insert and read bookmarks.
- * Allows to download data through PCLink from our website.

✕ Animated Phrases

- * Provides four main verbs, eight basic verbs and main prep & link words, helps to understand the meaning and usage of phrases through animation.
- * Role play, read after the device and quiz can correct pronunciation and differentiate phrases.
- * Allows to cross search in the corresponding dictionaries.
- * Allows to download data through PCLink from our website.

✕ Animated Dictionary

- * Includes high school vocabularies and popular words.
- * Provides built-in animation examples and detailed Chinese/English



Multi

explanations, provides words, example sentences, English to Chinese/Chinese to English/both, such data for reference, provides human pronunciation for words, sentences and integrated practice.

✕ Illustrated Dictionary

- * Provides various illustration to learn English words.
- * Allows to cross search in other dictionaries, and provides comparison in Chinese and English for the present scene.

✕ eBook

- * eBook browser, you can download data from website to device.

✕ My Album

- * Support displaying .bmp, .jpg and .png files. Provides picture and image frame setting.

✕ MP3

- * Supports simultaneous conveyance of sound and lyrics, provides A-B record playing function.
- * All the data in C:\MP3 can be settled as the alarm of device.

✕ Digital Recorder

- * Allows to record and play the phonic data.

✕ Games World

- * There are plenty of games on our website for you to download, all download games can be deleted.

✕ Text Browser

- * Supports displaying .txt files. Provides font size switching, font type choosing, background color setting and text reading.

✕ Flash Player

- * Played the flash files which are transferred into .swf, .bfh and .flv format.



Multi

1. Video

Allows to play files in format of .wmv, .rm, .avi, .rmvb, .pav, .bav.

Playing screen of Video





Device allows to play the format of files:

Video	format	screen size	bit rate	frame rate	audio
	.wmv	480*272	300kbps	about 20fps	64~128kbps
	.rm		200~300kbps		64kbps recommended
	.avi		500kbps		
	.rmvb		200~300kbps		

: [R] key, to contrast pronunciation again during reading after the device.

: [F] key, to read after the device, press [ESC] to stop.

: [T] key, to select caption display mode.

: [C] key, to open and select among “Play Single, Loop One, Play By Order, Loop All and Play List”.

: [L] key, to start to play the film.

: function same as the page up key, show to play the previous film.

: function same as the page down key, show to play the next film.

: [P] key, to play/pause film.

: [S] key, to stop playing.

: [M] key, to view the film by full screen.

Notes:

1 Please download the files to device, then it will automatically to search the files.



Multi

Press [SHIFT], then press [SAVE] to view the help.

2. Animated Study series

※ Take “Animated Grammar” for example:

Animated Dictionary contains lots of animated pictures to introduce usage feature of every grammar. It provides an interesting vision way for users to learning grammar.

Access the catalog screen to choose the content

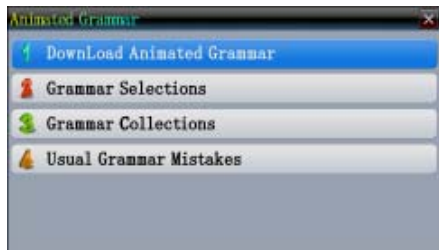

Device autos to search the data

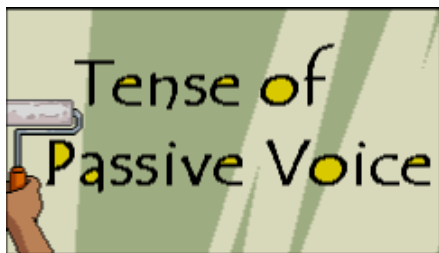

Open the information select menu





Multi

Open the Grammar Selections

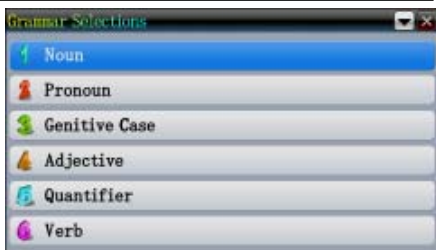

3. eBook/Text Browser

eBook Browser



Function list of Text Browser

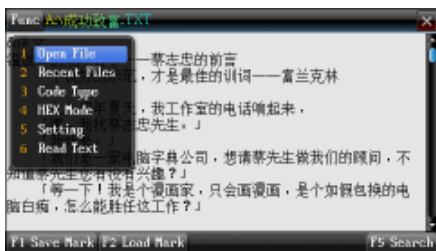

4. My Album

Image browse screen, tap [FUNC]--[Search] to go on searching the photos

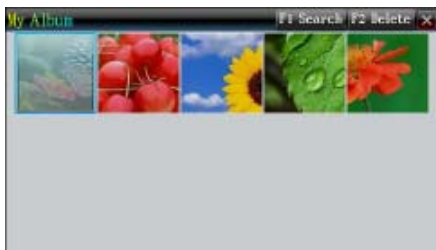



Multi

Tap or press direction key to choose and view the photo by full screen, tap screen of viewing photo to open the function select menu



: to change the color of plate.

: Enlarge to fit/best fit.

: previous/next image.

: anticlockwise/rotate clockwise.

: slide show setting.

: View the file's name.

: zoom out/in.

: slide show the image.

: flip horizontally.

5.MP3

simulate playing and A-B record playing



MP3 mini screen

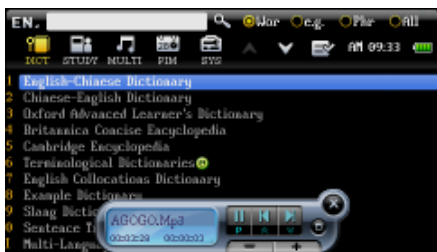



Multi

- * Tap / / to switch to Lyric List/Skin List/Play List. Tap to show two types of skins of MP3 for users to select.

Default Skin



"FOREST" Skin



- * Tap to language of lyric
- Tap



- * Tap to show the lyrics or the list of songs.
- * Tap to select order of playing.
- * Tap / to open/close the repetitive playing state.
- * Tap / to set bit/stop bit, and / will be played when you are setting.
- * After setting, the device will play the section between and .



Multi

- * When pause or stop, the lyrics can be cross searched.
- * Tap [ESC] to close the MP3 screen when MP3 keep playing, you can tap  to open MP3 mini screen in other screen.

Notes:

- 1 Press [SHIFT] first, and then press [SAVE] to view the on-line help.
- 2 The function of simultaneous conveyance of music and lyrics can be realized only if the two files with the same name and with the suffixes as “.lrc” and “.mp3” are put into the same folder.

6. Games World

Main menu of Games World

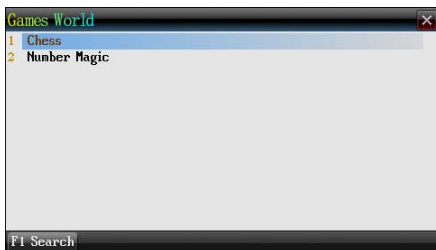

Tap [F1 Search] to go on searching games

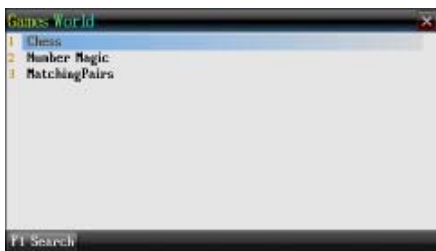



PIM

PIM Summary

- ◆ Provides the functions that Name Card, Memorandum, Schedule, To do list, Anniversary, Class Schedule and Income & Expense have following features:
 - * Create information in Chinese/English, numbers or special symbols.
 - * Allows to copy, modify, delete records or create new ones.
 - * Allows to set custom fields.
 - * Allows to secure data from unauthorized access.
 - * Allows to increase new categories which can be edited.
- ◆ Provides the functions of Calculator, Engineering Calculator and Conversion.

✕ Name Card

- * Provides personal information record.
- * Provides portrait setting, index search and records view.

✕ Memorandum

- * With the PIM common functions.

✕ Schedule

- * With the PIM common functions.
- * Allows to set alarm for important schedules, and to view daily and weekly schedules.

✕ To Do List

- * With the PIM common functions.
- * Allows to set priorities, and to view work list of every day.

✕ World Time

- * Displays the local time as well as that of two other cities, and allows to adjust time, date and cities.
- * Provides timer and stopwatch.



PIM

✕ **Calendar**

- * Provides calendar from January 1901 to December 2099, provides AD and allows to display 6-months calendar and 24 solar terms.
- * Allows to check daily issues and constellations, and provides mark for scheduled days and anniversaries.

✕ **Anniversary**

- * With the PIM common functions.
- * Allows to record important days in lunar or solar calendar.

✕ **Class Schedule**

- * With the first two items in common functions.
- * Allows to check new contents of Class Schedule at any moment.

✕ **Paint Brush**

- * Provides drawing tools to produce graphics.
- * Allows to copy, modify, delete a record or create a new one and to set drawing as startup picture.

✕ **Calculator**

- * Provides standard calculator and Engineering calculator.

✕ **Conversion**

- * Provides “Unit Conversion”, “Size Table” and “Currency Exchange”.

✕ **Alarm Setting**

- * Provides various alarms and allows to set alarm time, no alarm day and alarm interval.

✕ **Income & Expense**





- * Provides the record and management of your daily incomes and expenses, provides encode and total sum of your incomes and expenses.



1. PIM

1.1 Data Input

Input data in the corresponding fields of Name Card, Memorandum, Schedule, To do list, Anniversary, Class Schedule and Income & Expense with provided or downloaded input method.

- ① Input data in the fields:
 - * Tap the corresponding input method to input data.
 - * Tap  to open the drop-down menu.
 - * Tap  or press the Up/Down key to scroll up/down.
 - * Tap  or press the Page Up/Down key to view on the previous/next page.
 - * Tap  or press [ENTER] to start from a new line.
 - * Tap or press [SAVE] to save data.
 - * Press [ESC] to close the window after selecting the corresponding item.
- ② Allows to set custom category. (Unavailable in Class Schedule)
- ③ Allows to edit new category. (Unavailable in Schedule, To Do List, Anniversary, Class Schedule)

1.1.1 Custom Field

* **Take Name Card as example**

You can set up to 6 custom fields, all of which can be deleted in <SYS --Memory Management>.

- ① Tap [Func] to select "2 CustomField".
- ② Tap item to input data.
 - * Then tap  to open the dropdown menu.
- ③ Tap [Finish] or press [SAVE] to save data.

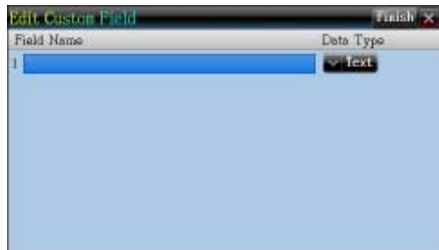



PIM

1.1.2 Edit Category

There are five categories--Business, VIP, Private, Relative and Friends for Name Card. You may add three more categories for your choice.

For Memorandum, there are three categories--Daily, Business and Family, you can also add five more.

All the categories can be renamed. The custom categories can be deleted in Memory Management.

1.2 Data Index

If there is saved data, the index will appear when the function is accessed. You can delete or lock data on index screen.

- ① Name Card: If the entry contains photo, tap 😊 to look up the portrait. If not, directly access the details. Tap telephone number to view other number list.
- ② Memorandum: Displays the list of categories first when you access, and then displays the index screen of the selected category.
- ③ Schedule: Allows to look up One/All, Week/Day Chart on the index screen.
- ④ To Do List: Allows to search date on the index screen.
- ⑤ Anniversary: Allows to look up lunar/solar calendar on the index screen.
- ⑥ Class Schedule: Index screen is not available. Tap the course directly to view the details.

View the portrait





PIM

View the phone No.

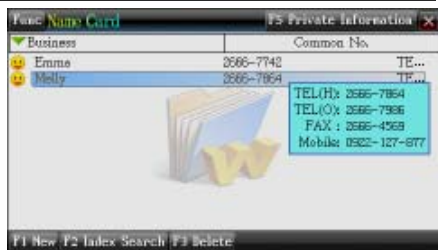

1.3 Detail View

You can view the details of data, and modify, copy and delete data. Besides, words can be cross searched in corresponding dictionaries.

2. World Time

- ① Provides date and time display for local city as well as others.
- ② Provides local city, date and time settings.
* Tap time/date/city name on the screen to set.
- ③ Provides timer, stopwatch.



3. Paint Brush

- ① Provides 12 tools and 41 functions.
- ② Provides 14 functions bars.
- ③ Provides 65,536 colors.

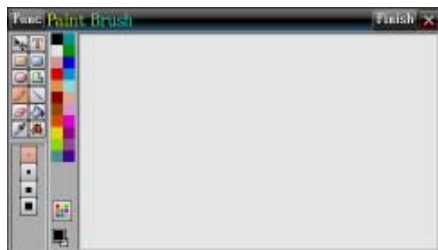



4. Calculator and Conversion

- ① Provides basic arithmetical, memory operations as well as percentage and square root.
- ② Provides Engineering calculations such as functions, trigonometry, logarithm, angle and radian conversions.
- ③ Provides dress, shoes, hat size comparison charts of America, Britain, Japan, Germany, Europe, etc.
- ④ Provides conversation function of 110 currencies and 2 user-defined currencies, as well as the exchange rate setting.



System Summary

- ◆ Provides function of device setting, it makes you operation easier.
- ◆ Provides Memory Management and File Management to clean up and manage your folders.

✕ PC Link

- * Allows to receive data from PC via PCLink.

✕ Memory Management

- * Allows to view the status of the main memory, optimize memory management and delete data.

✕ After Service

- * Provides BESTA information of Telephone, Fax, Website, OS Version, etc. Allows to upgrade system and view the copyright information.

✕ Password Setting

- * Allows to set, change or clear password and allows to lock/unlock private data.

✕ Startup Picture

- * Allows to set startup picture and background.

✕ Menu & Language Setting

- * Allows to switch among five kinds of menu displays: Chinese, English, Korean, Japanese and Spanish.

✕ Power Management

- * Allows to set auto power off time and power-saving time.

✕ File Management

- * Provides data management.



SYS

- * Provides function of data management, new folders created, rename, delete.
- * Allows to format the disk, rename files, exchange data between Extended Card and device.

✕ Sound Setting

- * Allows to set startup music/schedule alarm, turn on/off pen & key tone and select KK/DJ display.

1. PC Link

Connect the device with PC via PCLink cable, and then you can transmit data. There will be a message indicating the current connection status during and after transmission.

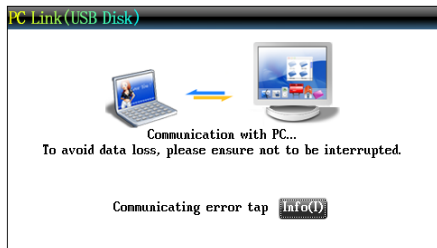

While connecting:

- !! please do not interrupt, otherwise data may be lost. please make sure there is enough power or the adapter is inserted.
- !! Before pulling out the USB connecting line, please uninstall the USB device safely.

2. File Management

This function allows to transmit data between card and the device. You can create new folder or rename folder.

Open the top path



Press [ENTER] to access the selected disk

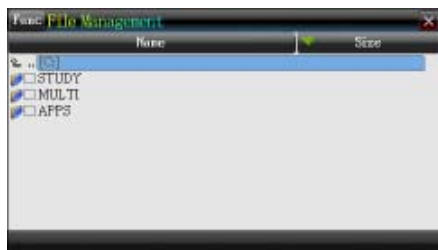

2.1 Creating New Folder

- ① Open the path in which you want to create new folder, and tap [Func] to select "2 New Folder".
- ② The default name of new folder is "MYDIR". Input new name and then press [ENTER] to confirm.

Creating new folder

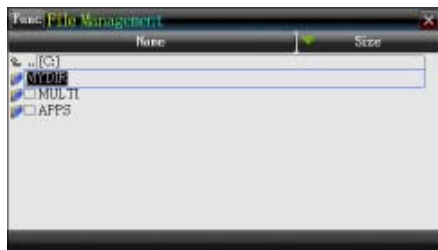



Copy data to device from card



2.2 Rename

- ① Choose your desired file, and then tap [Func] to select “3 Rename”.
- ② Input new file name, and then press [ENTER] to confirm.

2.3 Putting Folders in Order

- * Tap  to select item, as which the folders will put in order.
- * Tap “Name” to put folders in the order, which will be marked by  .

2.4 Format

Select disk or file to be formatted



Formatting







3. My Favorite

“My Favorite” provides 9 functions for users to set. After setting, you can tap  in the main menu to enter the function which set in “My Favorite”.

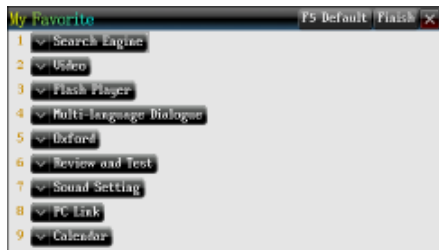
My Favorite screen



Tap  in the main menu

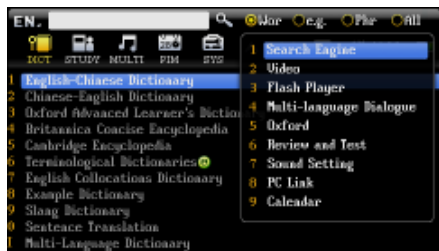



Index

Content of CD.....	68
1. PC Service Home Installation.....	69
1.1 S/W & H/W Requirements before Installation.....	69
1.2 Installation steps.....	70
1.3 Opening the Program.....	70
1.4 Communication.....	71
1.5 Data Management.....	73
1.5.1 Editing Data.....	73
1.5.2 Custom Field.....	74
1.5.3 Editing a category.....	74
1.6 Import/Export.....	75
1.6.1 Importing Data.....	75
1.7 Help.....	76
2. Service Toolkit.....	77
2.1 EbEditor.....	77
2.1.1 Creating a Project.....	78
2.1.2 Creating Text.....	78
2.1.3 Loading Images.....	79
2.1.3.1 Loading Images.....	79
2.1.3.2 Loading a Background Color.....	80
2.1.3.3 Converting a Batch of BMP Static Files into HCA Animated Files.....	80
2.1.3.4 Other Varieties--Shutter, BlockSlide.....	81
2.1.4 Setting the Moving Path.....	81
2.1.5 Adding Audio Effects.....	81
2.1.6 Setting a Page Header/Page Footer.....	82
2.1.7 Playing the Content.....	82
2.1.8 Downloading to the Device.....	82
2.2 Video Converter.....	82



Content of CD

The attached CD-ROM provides PC Service Home.



picture 1

✳ **Setup:** To install PC Service Home program, please refer to page 69~70.

Notes:

- ❶ For Windows2000 users, we suggest you install Windows2000 Service Pack 3 program provided by Microsoft. If Service Pack 3 is installed, you don't have to install USB driver program. Please select "USB Driver readme" in picture 1 to follow the instructions to install.
- ❷ For Windows2000 users, please access super administrator (Administrator) to log in.



PC Service Home Guide

1. PC Service Home Installation

PC Service Home provides ten functions: Media Download, Personal Information Manager, Synchronization Center, Backup and Restore, CD Express, Open U-Disk, Service Toolkit, Internet Download, DIY Dictionary and Settings, which have these following characteristics:

- * Download multimedia files like films, pictures and eBooks;
- * Edit and manage data for Schedule, Name Card, etc;
- * Synchronizing data between PC and the device;
- * Backup and restore PIM data for Name Card, Memorandum, Schedule, etc;
- * Service Toolkit contains EbEditor and Media Factory that combine with text, sound and picture;
- * Share data between PC and the device;
- * Provides tools which can convert the media file on PC into .bav or .dsy that used only in our device.

1.1 S/W & H/W Requirements before Installation

You need to install PC Service Home program into your PC. The following are the system requirements:

- * Traditional Chinese/English/Windows2000/XP/Vista operating system;
- * CPU: Pentium (R) III 450MHz or better;
- * LCD: VGA 800*600 or better, which is supported by Microsoft Windows;
- * Version 5.5 version of Microsoft Internet Explorer or above;
- * Minimum 650 MB of hard disk;
- * CD-ROM;
- * sound effect card.

1 PC Service Home Guide

Notes:

When using the PCLink in English operation system, please make sure to install Chinese Traditional font support: “Chinese (Traditional) Text Display Support” and “Chinese (Traditional) Text Input Support”.

1.2 Installation steps

- ① Insert the disk to PC, then there will appear a picture (as picture 1), tap “Setup” to install.
- ② Enter the screen of “Welcome to the Install shield”, click “Next”.
- ③ Enter the screen of “Choose Destination Location”, click “Browse...” to select file folder of destination.
- ④ Click “OK” to confirm the selection in the screen of “Choose Folder”.
- ⑤ Click “Next” to select setup type.
- ⑥ Select “Typical”, and click “Next” to access to the screen of “Select Program Folder”. Then click “Next” to continue.
- ⑦ The Install Shield Wizard begins to install EBook Editor to your computer.
- ⑧ After installation is completed, click “Yes” or “No” to select whether to restart your computer now, and then click “Finish” to end.

Notes:

To uninstall PC Service Home program, please access “Control Panel” → “Add/Remove Programs”. (Also can from “Programs” → “PC Service Home” → “Uninstall PC Service Home”)

1.3 Opening the Program

Click “Start” menu → “Programs” → “PC Service Home” → “PC Service Home 2.0”, or double click the shortcut “” in desktop to open. (as picture 2)

1 PC Service Home Guide



picture 2

Notes:

Please use standard font type in Windows to optimize PC Service Home display.

1.4 Communication

Data communication is one of the functions in PC Service Home, including Media Download, Synchronization Center, Backup and Restore, CD Express and Open U-Disk.

- * Media Download: Download applications, eBooks, etc, to the device.
- * Synchronization Center: Synchronize data in the device and PC, which will overwrite old data by new one and always keep contents the same; the synchronized function supports PIM applications, such as Anniversary, Schedule and Name Card.
- * Backup and Restore: Backup all data of the device in PC. To restore all the backups from PC to the device.

1 PC Service Home Guide

- * CD Express: Transfer music in CD-ROM to the device in MP3 format.
- * Open U-Disk: Move, copy, delete and append file folder, etc., into PC via USB.

Notes:

PIM (Personal Information Management) means the data saved by user.

Take “Media Download” as example to introduce operation steps:

- ① Connect USB cable into the corresponding sockets, device will enter the picture of “PC Link (USB Disk)”.
- ② Click “Media Download” in PC Service Home to access the downloading screen.
- ③ Select category list (such as “eBook”), right-click and select “Open” to browse the content. (Video and MP3 files can be played by Preview Media. You can also browse the information before downloading.)
- ④ Select the desired category and file, and then click “Download” to download into the device.

Notes:

- ❶ *Please do not remove the cable, close the PC Service Home program or turn off the power while synchronizing, they may cause system corruption and damage to your data.*
- ❷ *Tap “Scan e-dictionary” can search current title(s) in the device, if some title(s) which are not the default path, can automatically move the title(s) to the default path in order to make the operation easier.*

* Backup and Restore

Repeat steps ① and ② of “Download”. Click  Backup and Restore, and then select “Yes” to arrange the path where you’d like to keep backup file. Input file name (*.BBK) and select “Save” to backup files. If click “No”,

1 PC Service Home Guide

select the files to be restored to BBK format, and then click “Open old files” to place it back to the device.

* **Synchronization Center**

Repeat steps ① and ② of “Download”, and then click  Synchronization Center.

* **CD Express**

Allows to transfer music in CD-ROM in the form of MP3 directly to your device.

* **Open U-Disk**

Repeat steps ① and ② of “Download”, and then move, copy, delete or create new file folder.

* **Internet Download**

Please go to our website to download and update data.

* **DIY Dictionary**

Import the DIY Dictionary in the device, and the contents can be created or modified.

* **Settings**

Set “ADS Center, ADS Check, Media Download and System Settings” respectively. Tap  Settings, and then tap “ADS Check” to set.

1.5 Data Management

This allows you to append, modify data, edit category, and custom field name on PC in PIM applications: Name Card, Memorandum, Anniversary, Schedule, To Do List, Class Schedule and Income & Expense.

1.5.1 Editing Data (Take “Name Card” as Example)

- * Click “New Record” → “Name Card”. You may append Name Card data on the editing screen. (as picture 3)
- * To modify the content, double click the entry. (as picture 3)

1 PC Service Home Guide

- * To copy, paste or delete one or more entries, select the entries first.

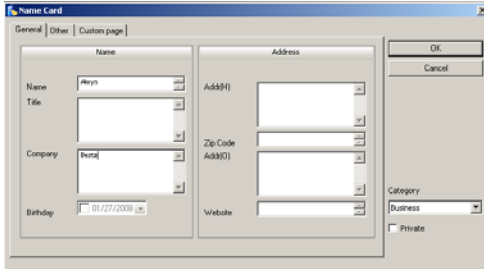

picture 3

Notes:

Tap “Custom page”, and then Click the blank area of “Portrait” to import BMP or JPG file as Name Card portrait.

1.5.2 Custom Field

Click “Edit Custom Fields” to add custom fields besides the built-in fields. Up to 6 field types can be selected: text, date, time, integer, decimal, currency, or check box, shown in picture 4.

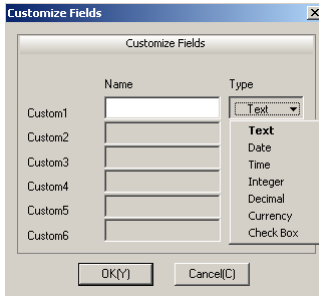

picture 4

1.5.3 Editing a category

In Name Card and Memorandum, you may add up to 8 categories (including built-in categories).

Tap “Manage Categories” in “Tasks Pane”:

1 PC Service Home Guide

- * Select “Name Card” → “Add” → input a new category “Teacher” (as picture 5);
- * Select “Delete” to delete the newly added category (built-in category can not be deleted);
- * Select “Rename” to rename the selected category.

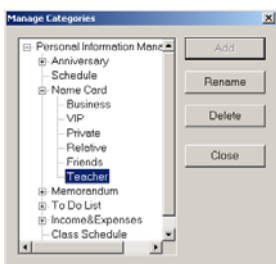

picture 5

Notes:

- ❶ Data can not be copied or pasted in different functions.
- ❷ Custom field is not available in Anniversary, Schedule, To Do List, Income & Expense or Class Schedule.
- ❸ The name of custom field/category is up to 16 characters.

1.6 Import/Export

You can import/export corresponding data of Schedule, Name Card, Memorandum, To Do List from PC Service Home to Outlook Calendar, Contact, Notes and Tasks of PC, and you are allowed to import/export vCard between both ends.

1.6.1 Importing Data (Take “Import Outlook contact” as Example)

Import Outlook contacts to PC Service Home as Name Card.

- * Click “File(F)” menu “Import and Export” → “Import Outlook contact”.
- * Tap “Next”, and then it displays “Import Outlook contact” window,

1

PC Service Home Guide

select data from the right area to be imported, click “Import” and then click “OK” to import. (as picture 6)

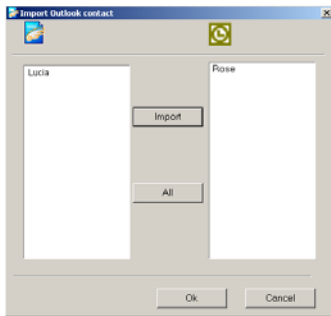

picture 6

1.7 Help

When you have question and difficulty about operation, please click “Help” → “Help(H)” menu to see the on-line help.

Service Toolkit

2. Service ToolKit

2.1 EbEditor





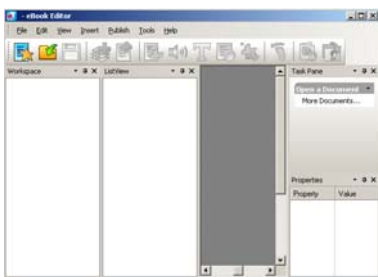





EbEditor is a software which supports 16 colors and color pictures combined with text, sound and pictures. You can make a vivid and interesting eBook or e-card by using the eBook editor in the CD/website.

Click “Service ToolKit” -- “EbEditor” in PC Service Home to access the eBook editor screen. (as picture 7)





picture 7

Tool list:

-  (Create a new cm file): To create a new project.
-  (Open existed file): To open an existed project.
-  (Save file): To save current project.
-  (Add CM): To add a new CM in the index of a project.
-  (Play eBook file): To play eBook with special effect.
-  (Add image): To add picture or animated cartoon in the current CM.
-  (Add sound): To add MP3 file in the current CM.
-  (Add text): To add text in the current CM.
-  (Add text button): The button of adding text in the current CM.
-  (Add output control): You may use macro function. please click “Help” menu → “Content” to view “Advanced functions of eBook Editor” of “Make your own eBook” → “Using Macro to optimize your eBook”.

2 Service Toolkit

-  (Play eBook): Play the eBook in the simulating circumstance.
-  (Convert images): To convert BMP file into HCA file.
-  (Set [start/end] Moving path): To set moving path for the text or image.



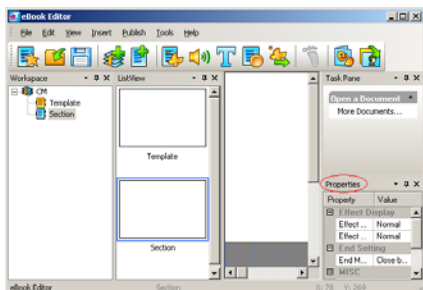

2.1.1 Creating a Project

- * On the “Index” screen, click icon  in the top left of the tool bar.
- * Input “Project Name” (you can name it by yourself)→ Select the model platform → click “OK”. (as picture 8)
- * Click the “Properties” bottom to modify the contents’ mode.



picture 8

2.1.2 Creating Text

- ① Tap  to create a new section, then click  to access text editing area.
 - * Input words in the text editing area directly.
 - * Tap  on the tool bar to choose the type of files (.txt or .html), then loading the files directly.
- ② Choose the type of the “words effect” what you want. (as picture 9)
- ③ Click “OK” and tap  to save text files at last.



Service Toolkit

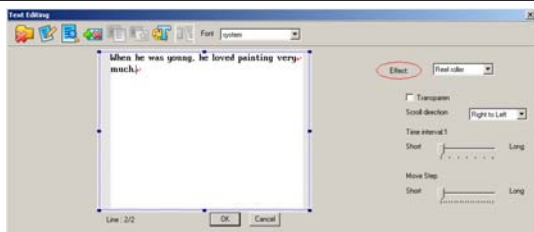



picture 9

2.1.3 Loading Images

Before loading images, you have to convert BMP, JPG or GIF format into HCA format. It is recommended that your images are less than 320*240 pixels.

2.1.3.1 Loading Images(Static Images, Animation Images)

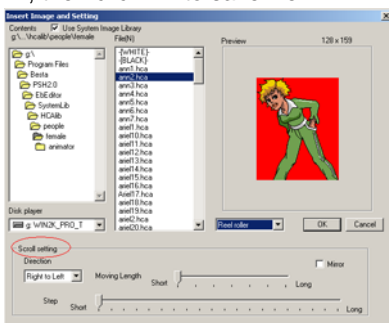

- 1 Select "Section" or  to add a new section, then click  from the tool bar.
- 2 Tick "Use system image library", select HCA file from file folder.
- 3 Select an image variety mode in the preview area (as picture 10): Normal, Reel roller, Stereo scroll.
- 4 Click "OK", then click  to save file.



picture 10

2 Service Toolkit

2.1.3.2 Loading a Background Color

- ① Select  from the tool bar.
- ② Click “-[BLACK]-”, then select color from the color plate at the bottom of the picture, Click “OK”.
- ③ Right-click in the editing area. Select “Layer” , select “Push to bottom”. then click  to save file.

Notes:

he background color will appear only when the text is transparent.

2.1.3.3 Converting a Batch of BMP Static Files into HCA Animated Files

- ① Click  to convert the images.
- ② Click “Open” to select all BMP files (files must be of the same resolution) to be converted as a countdown animation. then click “Open” to open.



ann1_a.BMP



ann2_a.BMP



ann3_a.BMP

- ③ Use “UP” and “DOWN” button to rearrange files in order.
- ④ Select the color of the images, please don't click “Batch Processing”.
- ⑤ Click “Compress”, and then select where to put the file folder and input file name.
- ⑥ Click “Save” to get an HCA animation file.

Notes:

It is recommended that you should name the files in sequential order, edit with number and put an underline between letter and digit. Please make sure that the color of the 16-color animated file you're converting

Service Toolkit

does not exceed 15-color limit. As for animation of 256-color, make sure the limit of 255-color is not exceeded.

2.1.3.4 Other Varieties--Shutter, Block Slide

- ① Select "Section setting" from the pop-up menu.
- ② Select a style from the drop-down menu of Begin and End: Horizontal shutter, Vertical shutter, Fade out.
- ③ Select an Ending mode: Close by animation, Close by key, Close by time.

2.1.4 Setting the Moving Path

You can set path in which the image or text is moved. Direction of the movement depends on the number you marked. You can set speed and length of the step for the moving path.

- ① Select a section, text or picture to be moved, Click .
- ② Left-click in editing area to set the order of path.(as picture 11)
- ③ Select moving length and delay interval. Click "Repeat play" if necessary, and then click "OK".

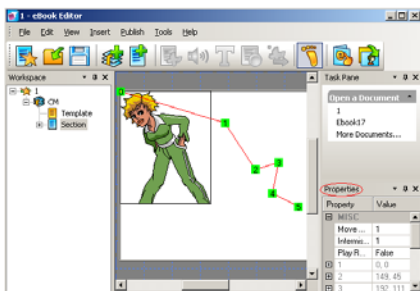

picture 11

2.1.5 Adding Audio Effects

- ① Select a section to add audio effect, Click .
- ② Click "System library", select an MP3 file (16kbps-320kbps) from the list.

Service Toolkit

- ③ Select play time, set start time, tick “Cycle play”, click “OK”.

2.1.6 Setting a Page Header/Page Footer

- ① Switch to the “Index” screen. Select “Edit”, then “Set Page header/footer”.
- ② Click “Insert” to insert page number, date and time at page header or page footer. You can input the content manually, then click “OK”.

2.1.7 Playing the Content

- ① Select  to play the eBook contents.
- ② Click page up/down to play the previous/next page; click “ESC” to close it.

2.1.8 Downloading to the Device

- ① Click “Media Download” to access the download screen.
- ② Firstly, click “eBook” in “Category List”, and then click “Scan” in tool bar, select (.book) files to download.
- ③ After searching, click files in “My Computer”, and then click “Download” icon to download.
- ④ You can select reading in <F4MULTI -- eBook>.

2.2 Video Converter

Video Converter is an easy film converting tool. It can convert the common media (mpg, mpeg, avi, dat, rm, rmv, mov, mp4, vob, asf, flv, 3gp) into avi file that can play in the electronic dictionary and PC.

- ① Open Video Converter. (as picture 12)





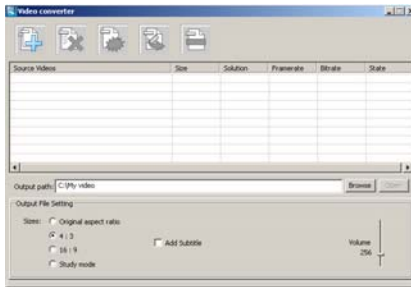



Service Toolkit



picture 12

Tool bar:

-  :Add the media files which need to be converted.
-  :Delete the files which you selected.
-  :Delete the files in the file list.
-  :Begin to convert files.
-  :Stop to convert files.

- ② Tap  to select the files which need to be converted, then click “OK”.
- ③ Tap [Browse] to browse the folder of output files, default path of SYS is: C:\MY video.
- ④ You could set size of the output files, default proportion: [4:3].
- ⑤ Use mouse to adjust the voice volume.
- ⑥ Tap , begin to convert to a avi format file. After finish converting, escape from the display frame, there will be a mention is “Conversion Finish”. (as picture 13)

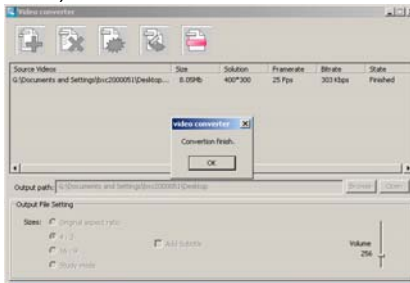

picture 13



Maintenance

Maintenance

1. Keep it dry. Precipitation, humidity and liquid that contains minerals will corrode electronic circuits.
2. Do not use or store it in dusty, dirty areas as its detachable parts may be damaged.
3. Do not store it in hot areas. High temperatures can shorten the life of electronic devices, damage batteries, and melt certain plastics.
4. Do not store it in cold areas. When the device warms up, moisture can form inside it, which may damage electronic circuit boards.
5. Do not attempt to take the device apart. Improper handling may damage the device.
6. Do not drop, knock or shake it. Improper handling may cause damage to the liquid crystal panel.
7. Do not use harsh chemicals, cleaning solvents, or strong detergents to clean the device.
8. Do not paint it. Paint can clog the device 's detachable parts and cause it to malfunction.

Do not operate the device below the temperature 0 or over 40 degrees. Excessive heat or cold will cause malfunction and incur damage to the device. To avoid such from happening, please do not use the device for two hours after it has been exposed to excess heat or cold, because the humidity or moisture formed by the temperature changing will cause damage to the device.

Specifications of Memory Card

Kingston Class 4 SDHC	4GB/8GB/16GB/32GB
Kingston Class 6 SDHC	4GB/8GB
Kingston SD	1GB/2GB
Sandisk UltraII Class 4 SDHC	4GB/8GB/16GB
Sandisk Extreme III Class 6 SDHC	4GB/8GB
Sandisk Standard Class 2 SDHC	4GB/8GB
Sandisk SD	2GB
Sandisk UltraII Class 4 SD	2GB
Sandisk Standard Class 2 SD	2GB
PQI SD	1GB/2GB
Adata Speedy SD	2GB
Adata Turbo 150X SD	2GB
Transcend SD	4GB
PDC SD	1GB
Sandisk Mobile Ultra Micro SDHC	8GB
Sandisk Micro SDHC	4GB/8GB
Sandisk Micro SD	1GB/2GB
Kingston Micro SD	2GB
PQI Micro SD	2GB
PDC MMC	1GB

FCC NOTICE

This equipment has been tested and found to comply with the limits of a Class B digital device, pursuant to Part 15 of the FCC Rules. These limits are designed to provide reasonable protection against harmful interference in a residential installation. This equipment generates, uses and can radiate radio frequency

energy and, if not installed and used in accordance with the Instructions, may cause harmful interference to radio communications. However, there is no guarantee that interference will not occur in a particular installation. If this equipment does cause harmful interference to radio or television reception, which can be determined by turning the equipment off and on, the user is encouraged to try to correct the interference by one or more of the following measures:

1. Reorient/Relocate the receiving antenna.
2. Increase the separation between the equipment and receiver.
3. Connect the equipment into an outlet on a circuit different from that to which the receiver is connected.
4. Consult the dealer or an experienced radio/TV technician for help.

CANADIAN NOTICE

This Class B digital apparatus meets all requirements of the Canadian Interference-Causing Equipment Regulations.